

Wärmepumpenkonzept Neusiedl am See

**Internationaler
Grosswärmepumpen Kongress**

Übersicht

- Ausgangssituation
- Ziele
- Winter/Sommer Betrieb – NEU!! Übergangszeit
- Technische Details – Eckdaten
- Umwelteffekt
- Zeitplan
- Forschungsprojekte

Fernwärmebedarf

NW Neusiedl: Leistungsdaten Fernwärme 2016

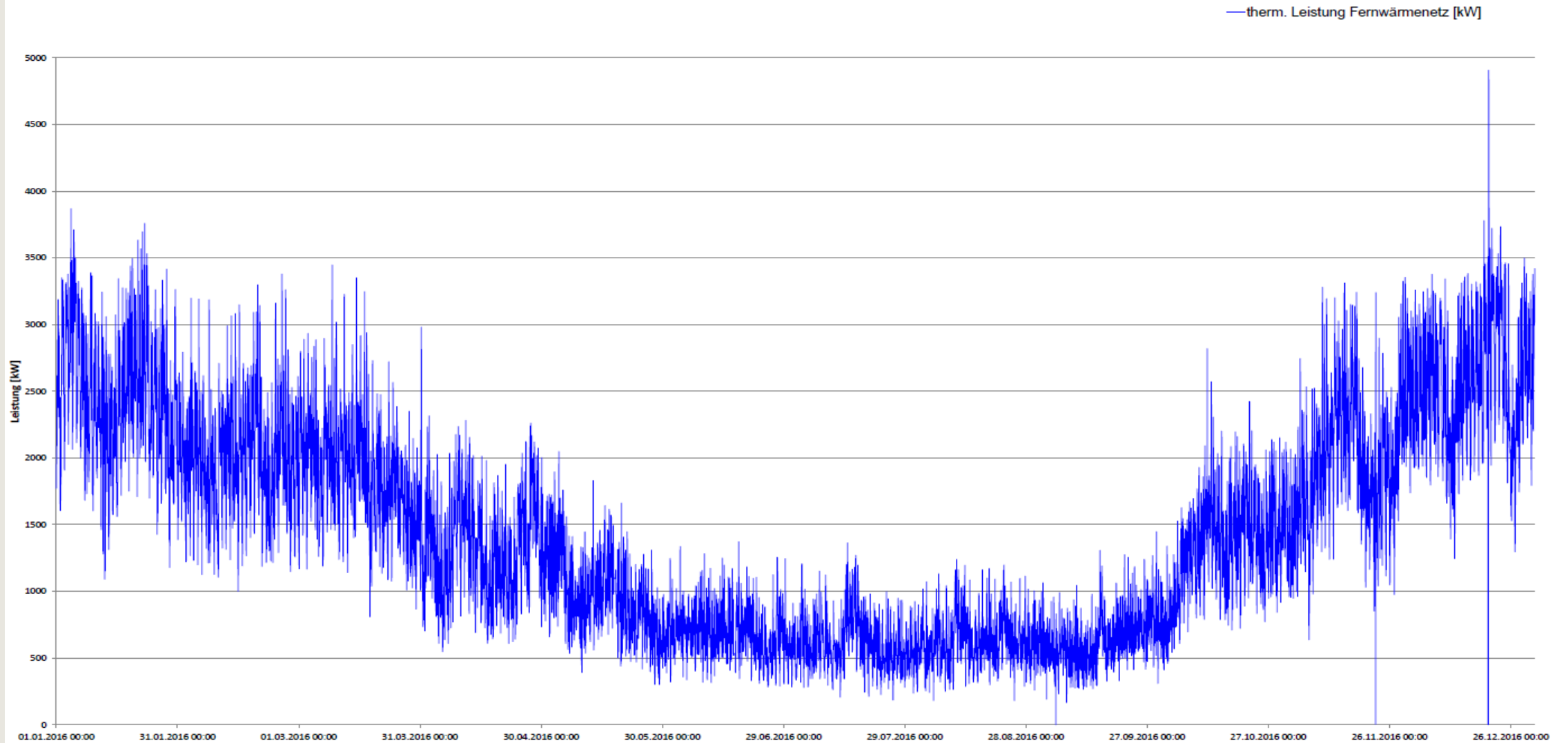

Stromproduktion vs. Fernwärmebedarf

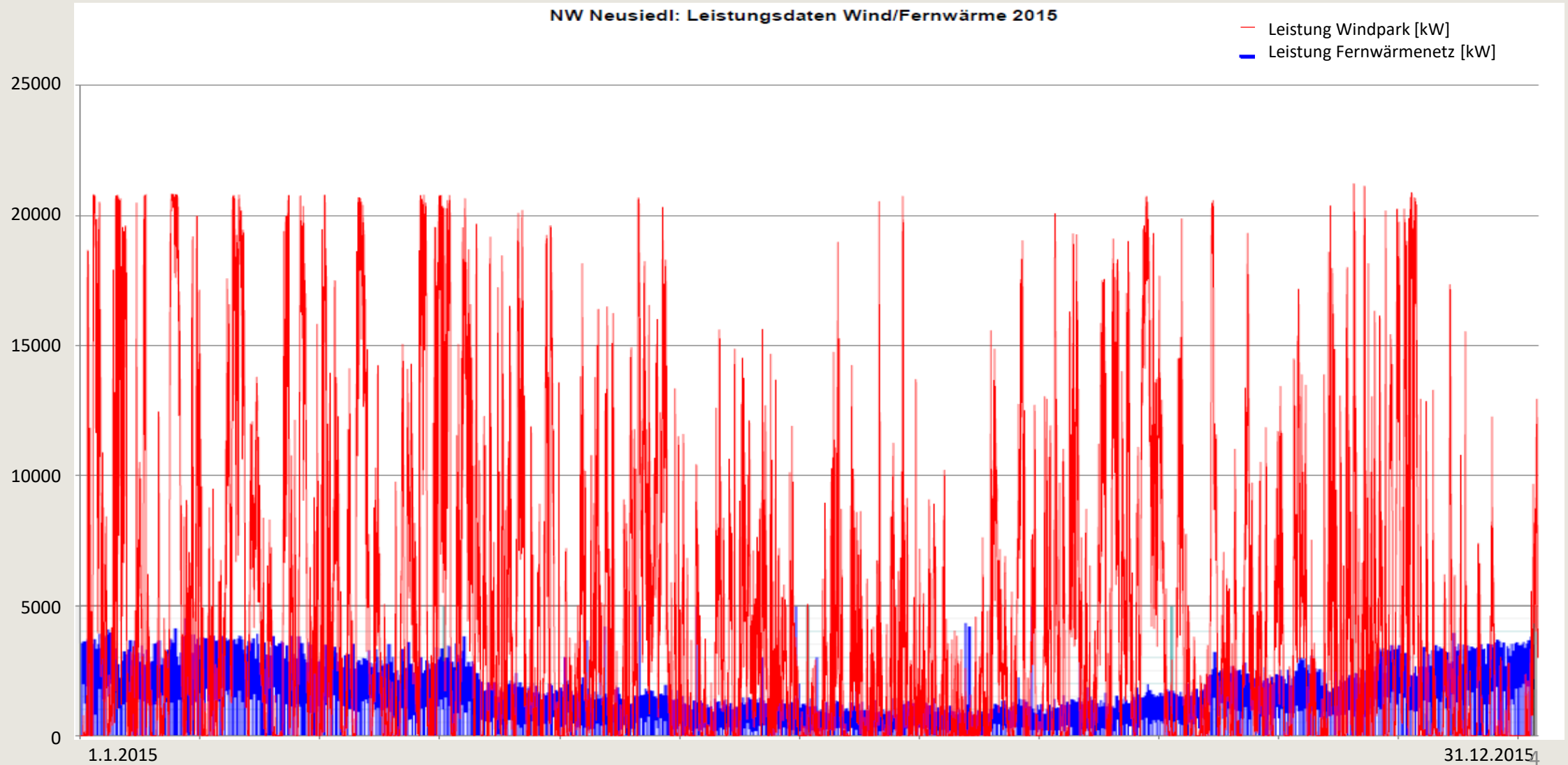

Projektziele

- Sinnvolle und optimale Nutzung von Windenergie
- Maximale Wärmeproduktion aus Windenergie
- Reduktion Erdgaseinsatz gegen Null
- Reduktion Biomasseinsatz

Wärmepumpenkonzept Neusiedl am See

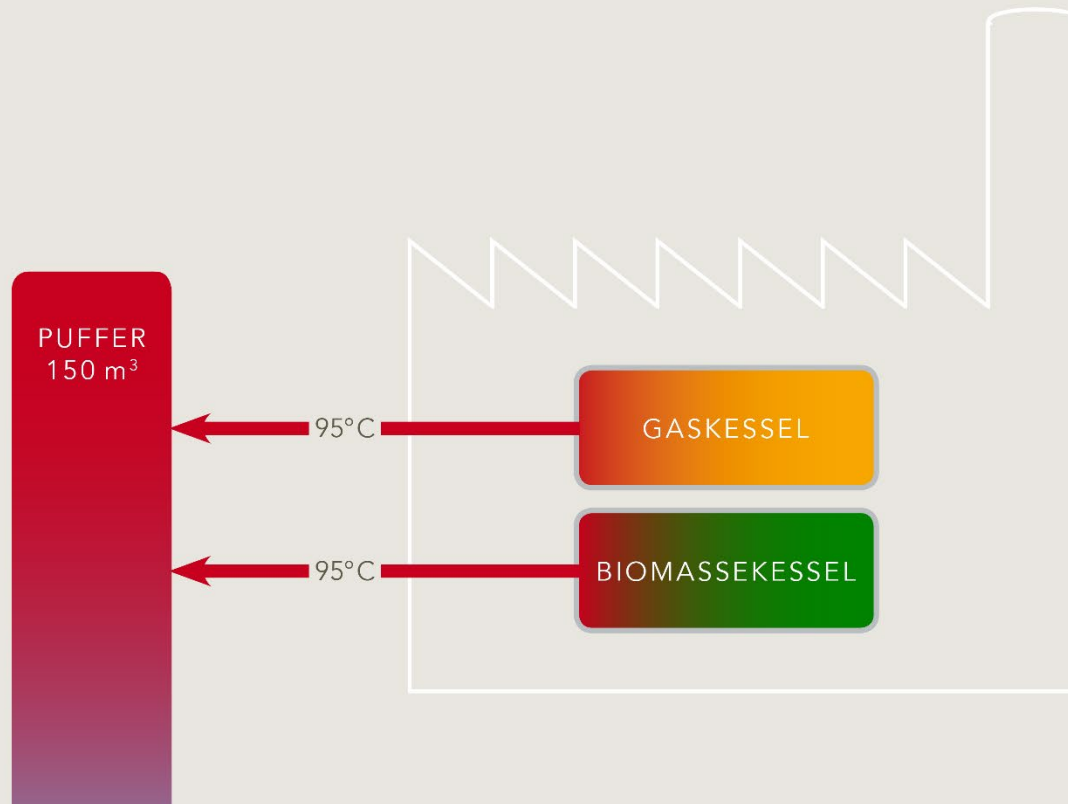



17 WINDENERGIEANLAGEN

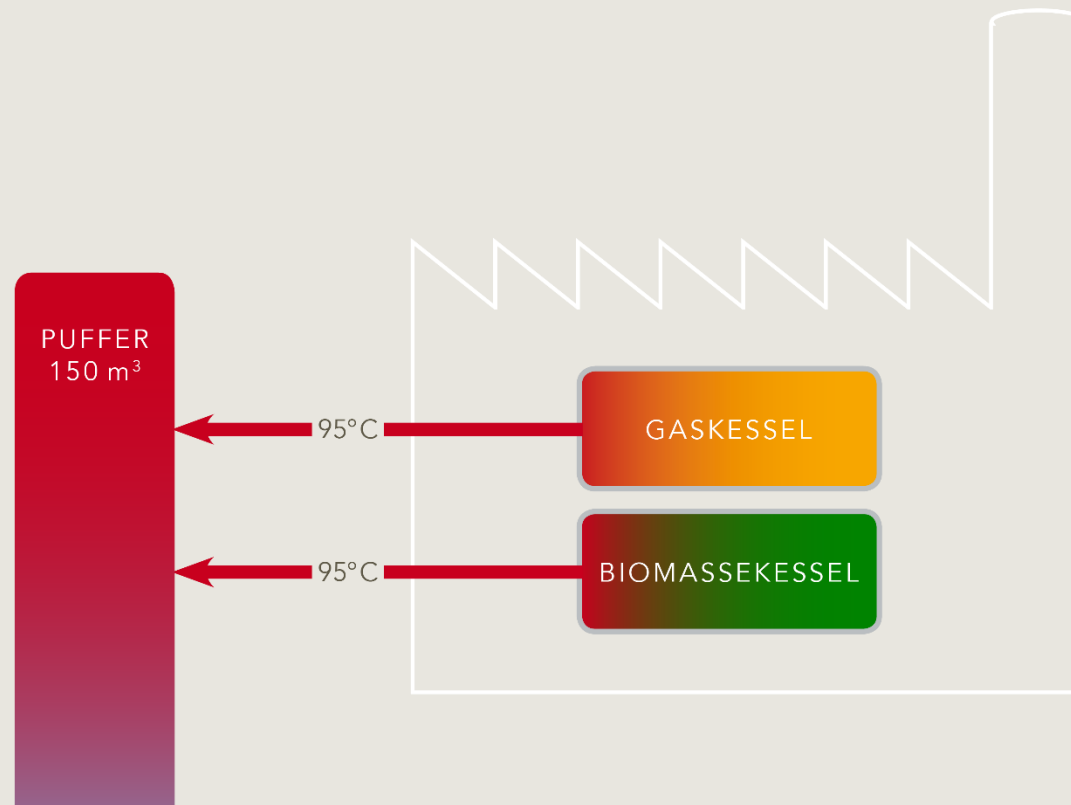

Wärmepumpenkonzept Neusiedl am See



17 WINDENERGIEANLAGEN

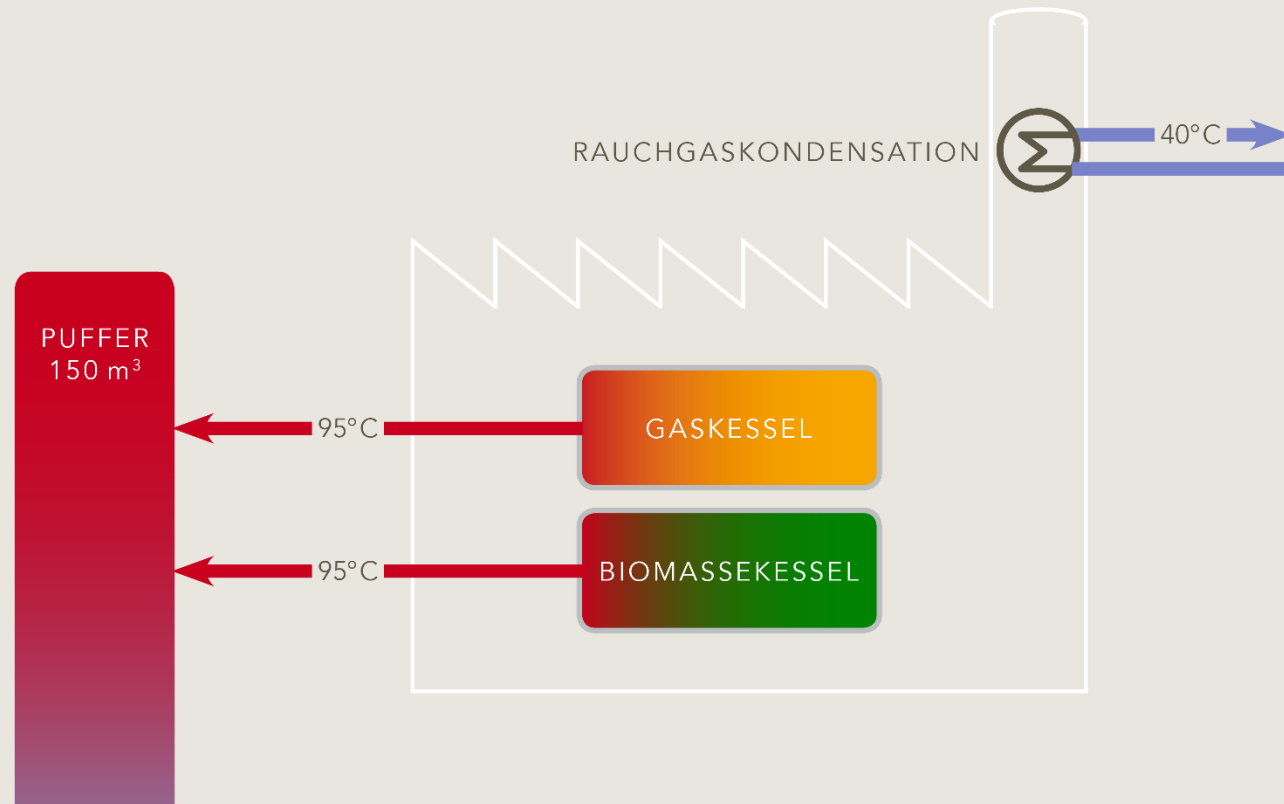



17 WINDENERGIEANLAGEN

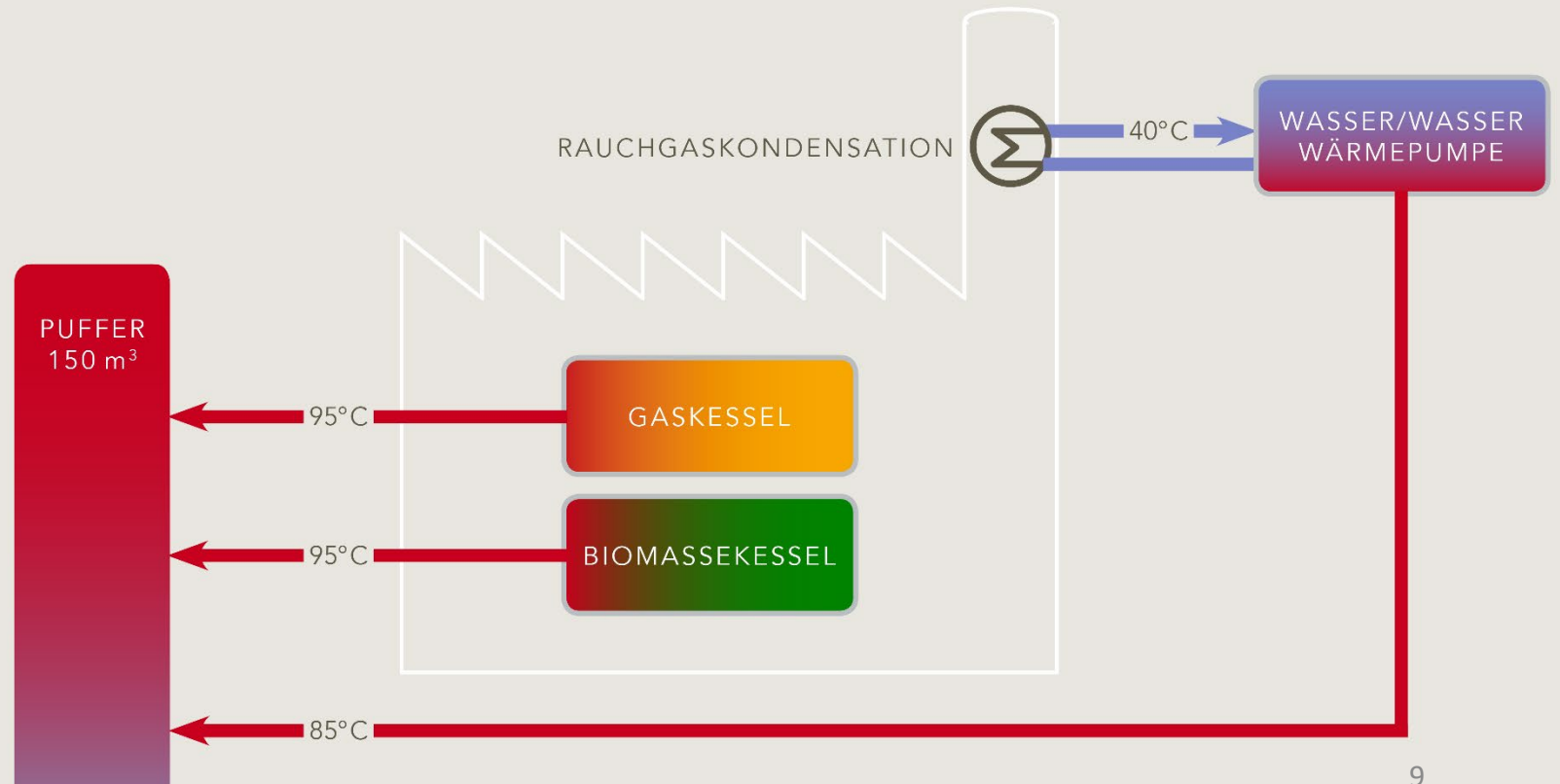



17 WINDENERGIEANLAGEN

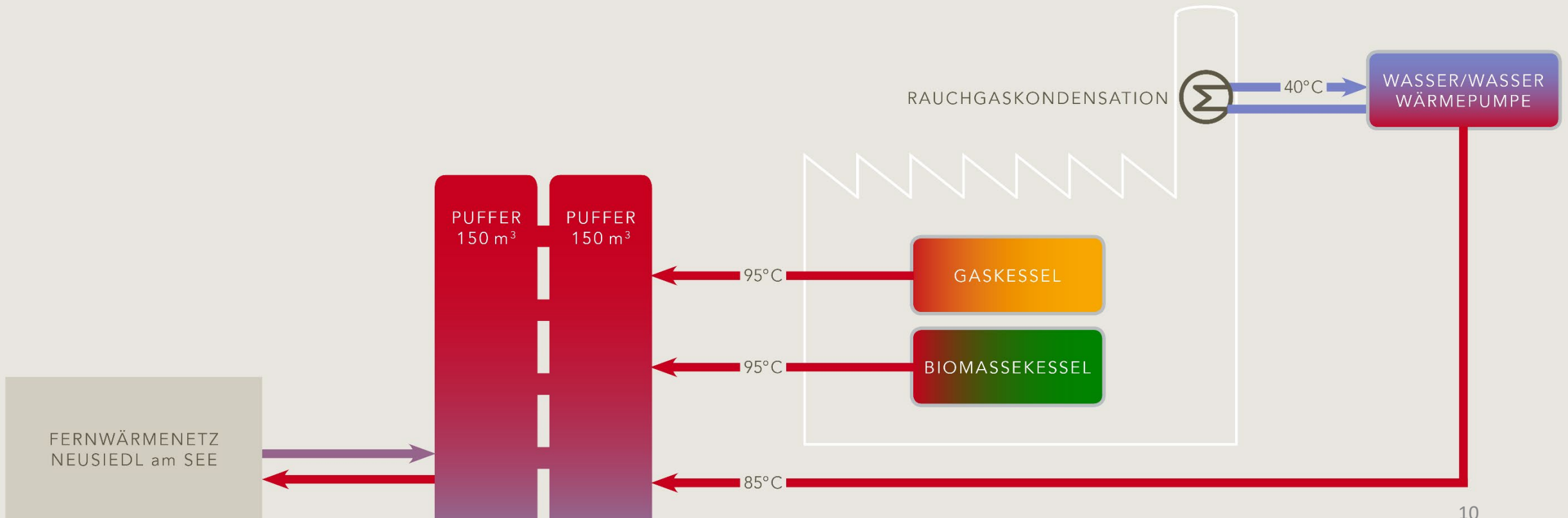



17 WINDENERGIEANLAGEN

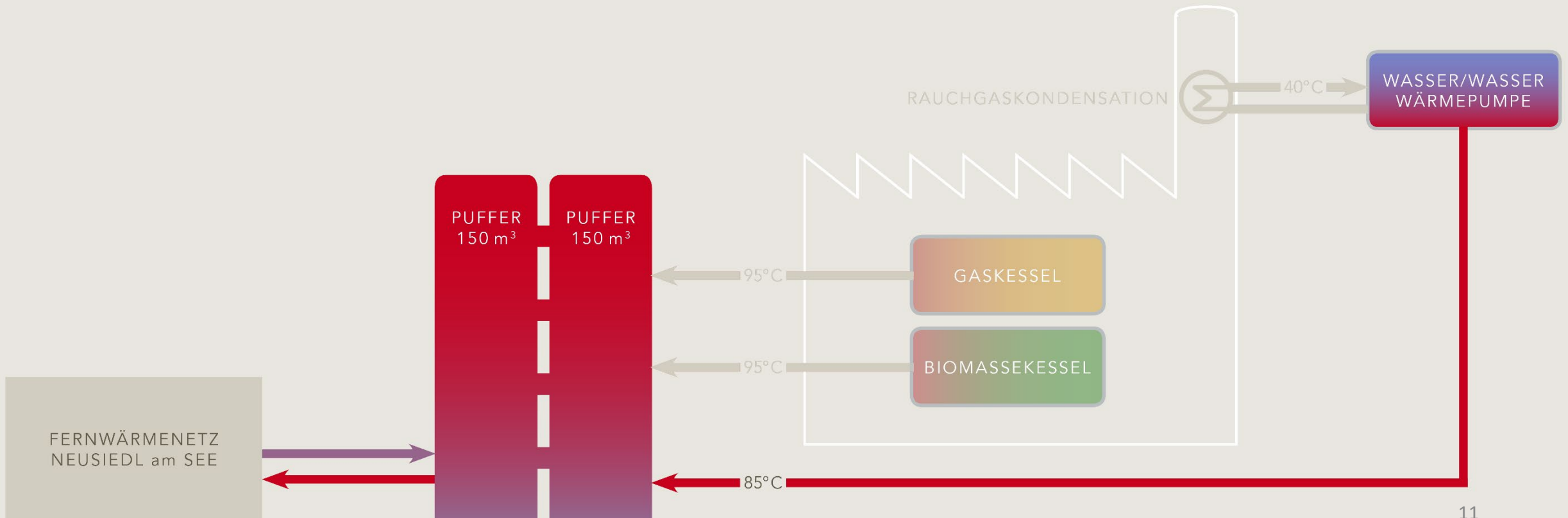



17 WINDENERGIEANLAGEN

Wärmepumpenkonzzept Neusiedl am See

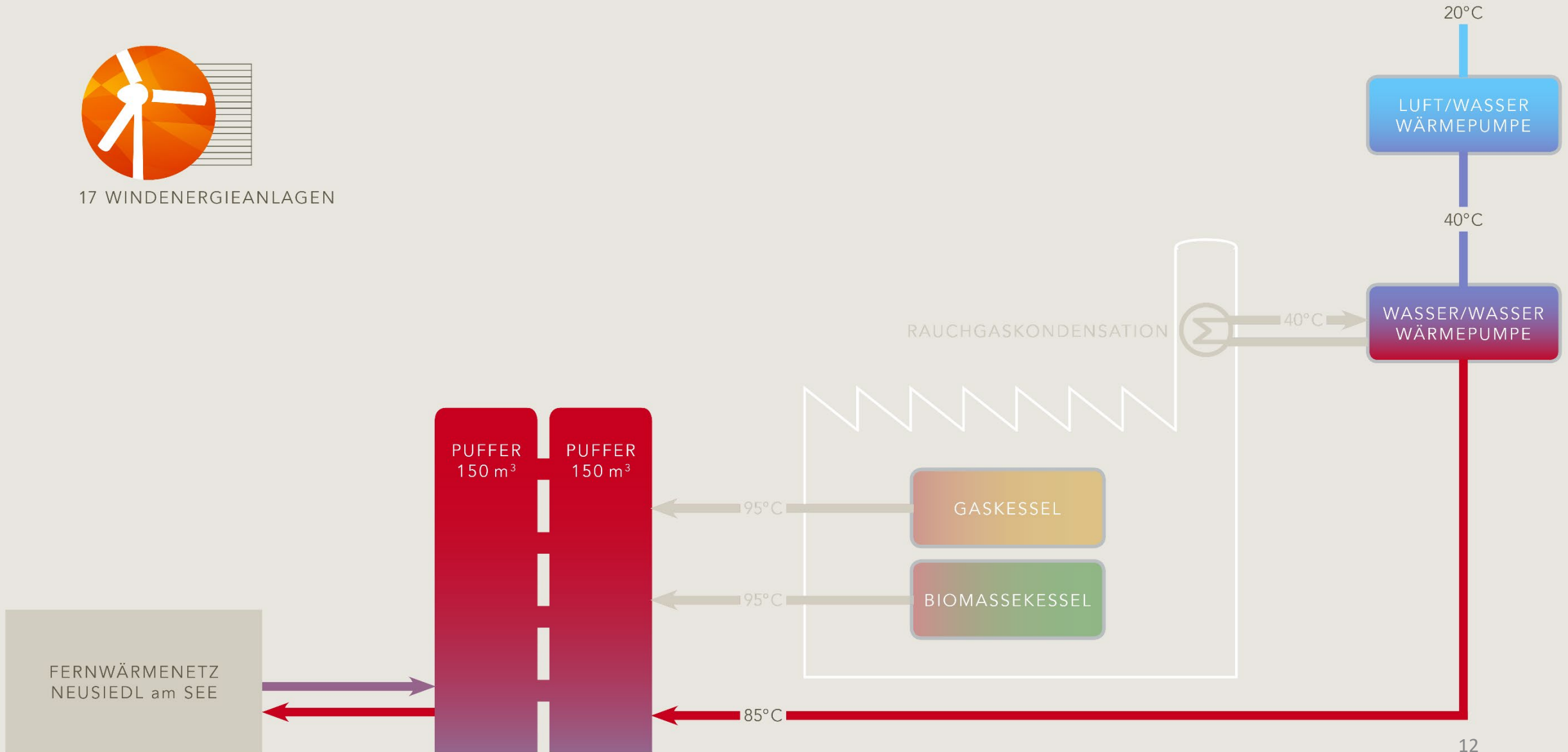

Wärmepumpenkonzept Neusiedl am See

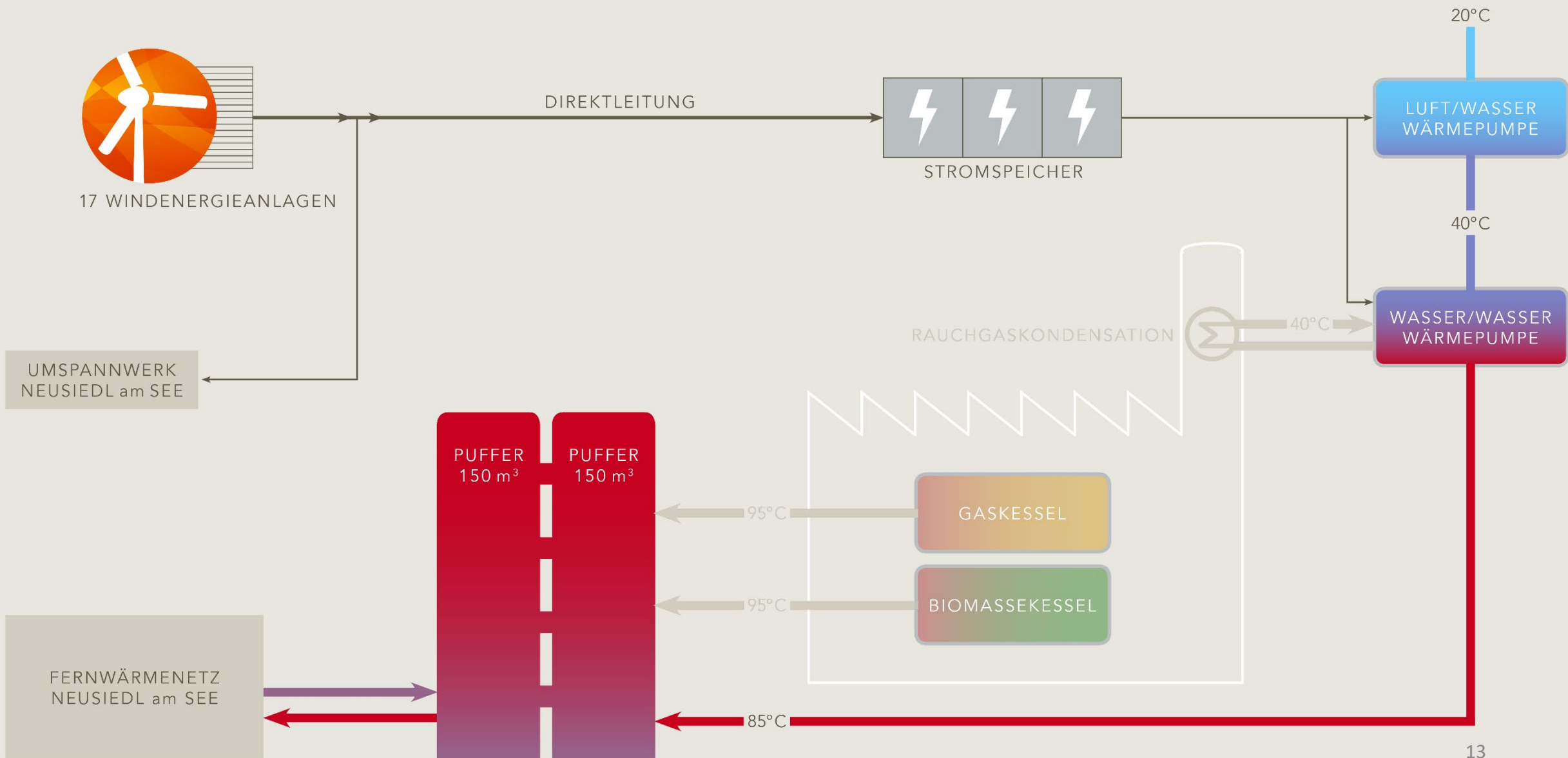

Schema

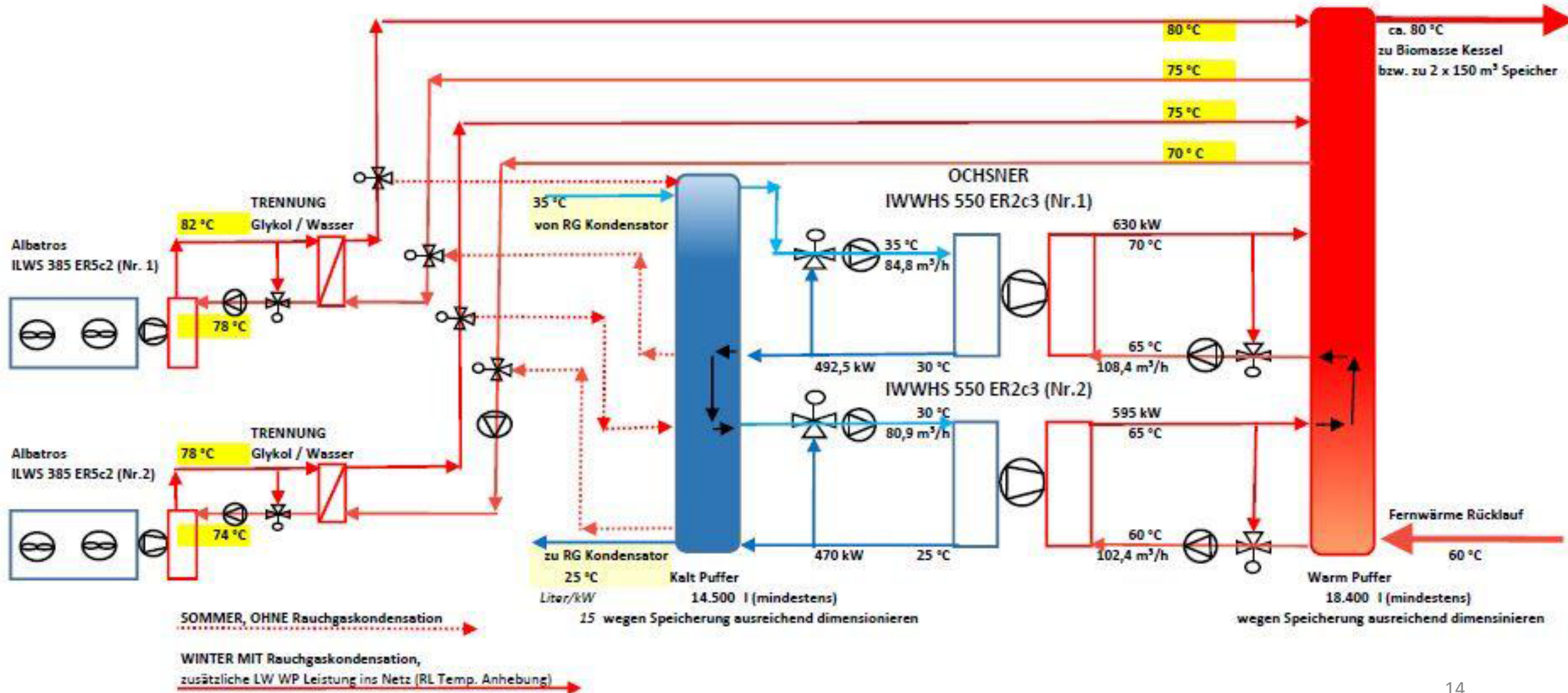

Verrohrungsplan

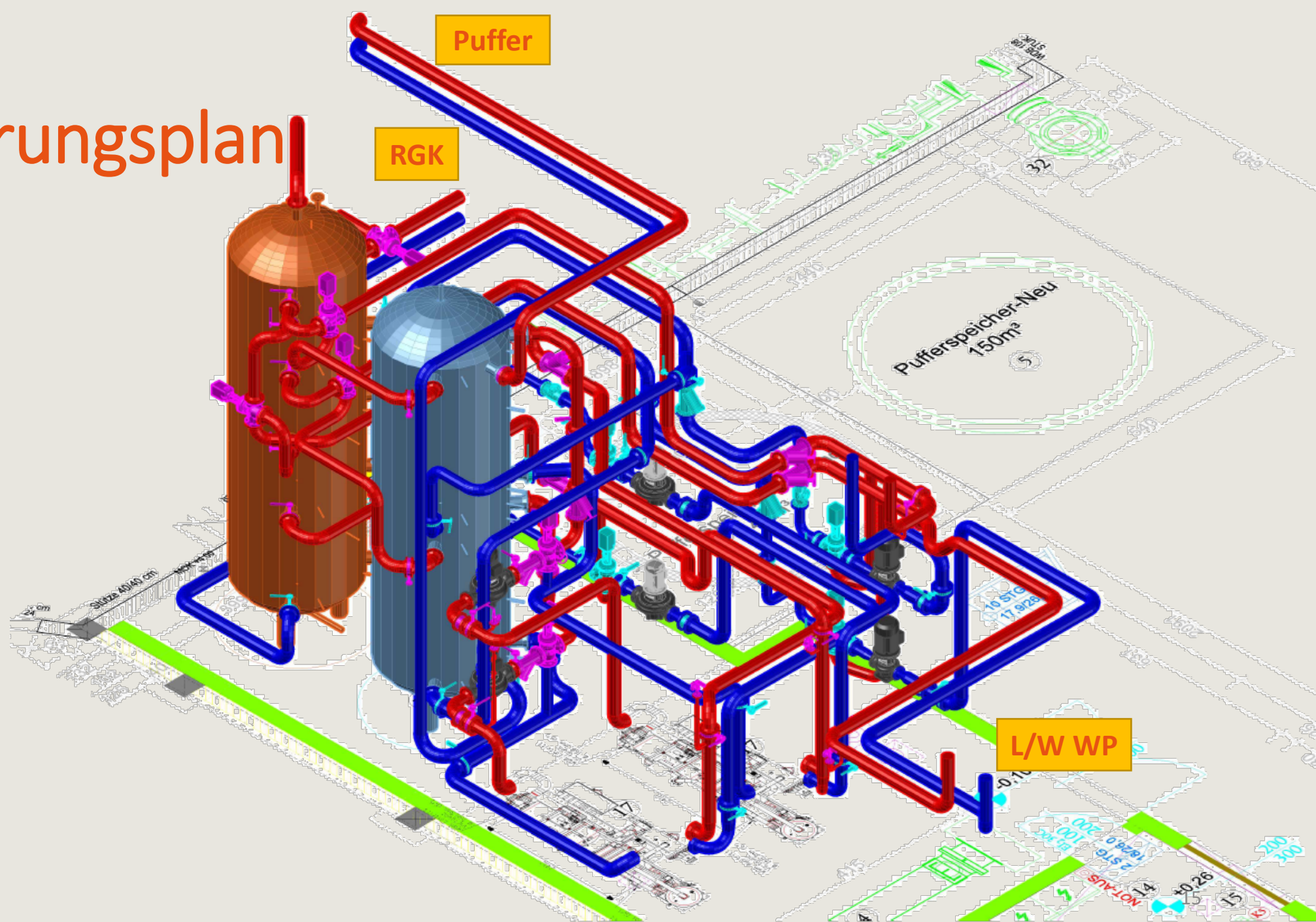

Direktleitung



Schema Rauchgaskondensation

- Rauchgasvolumenstrom: 16.400 m³/h
- Rauchgaseintritt: 180°C
- Wasseraustritt: 40°C
- Leistung: 966 kW

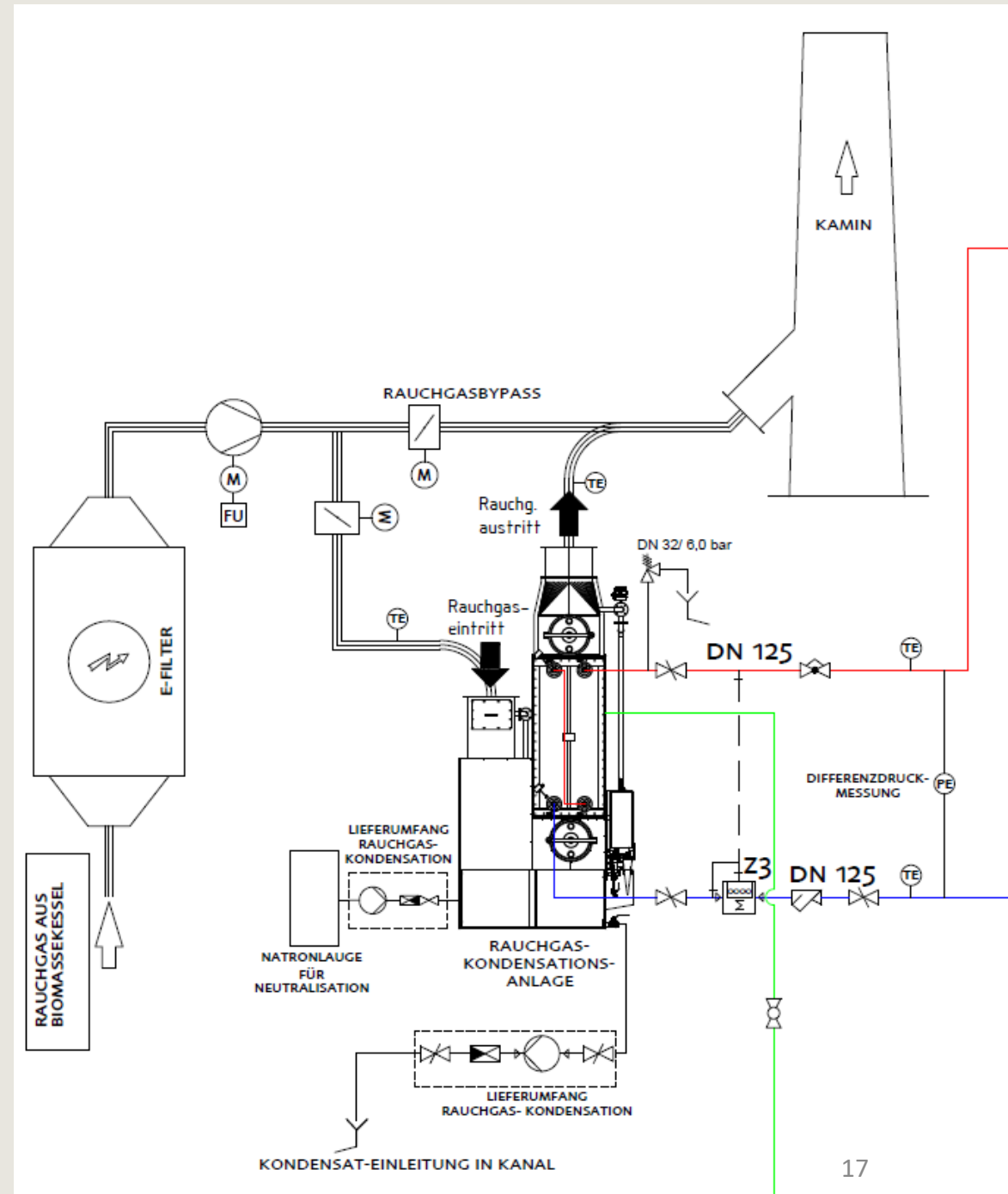

Umsetzungsplan

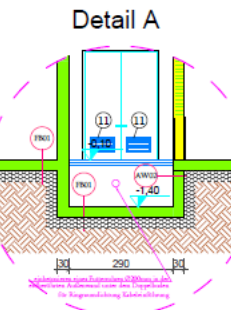
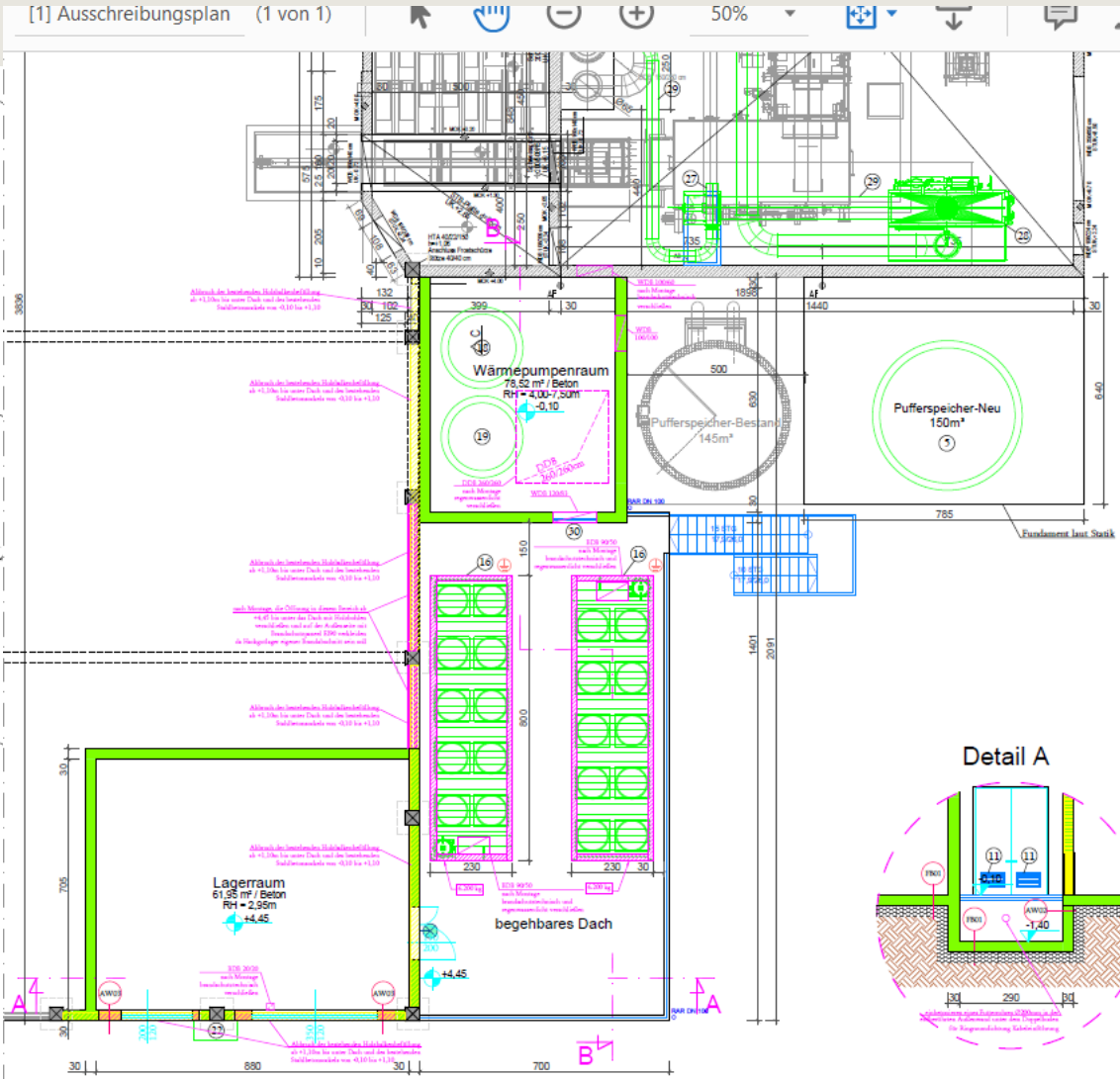
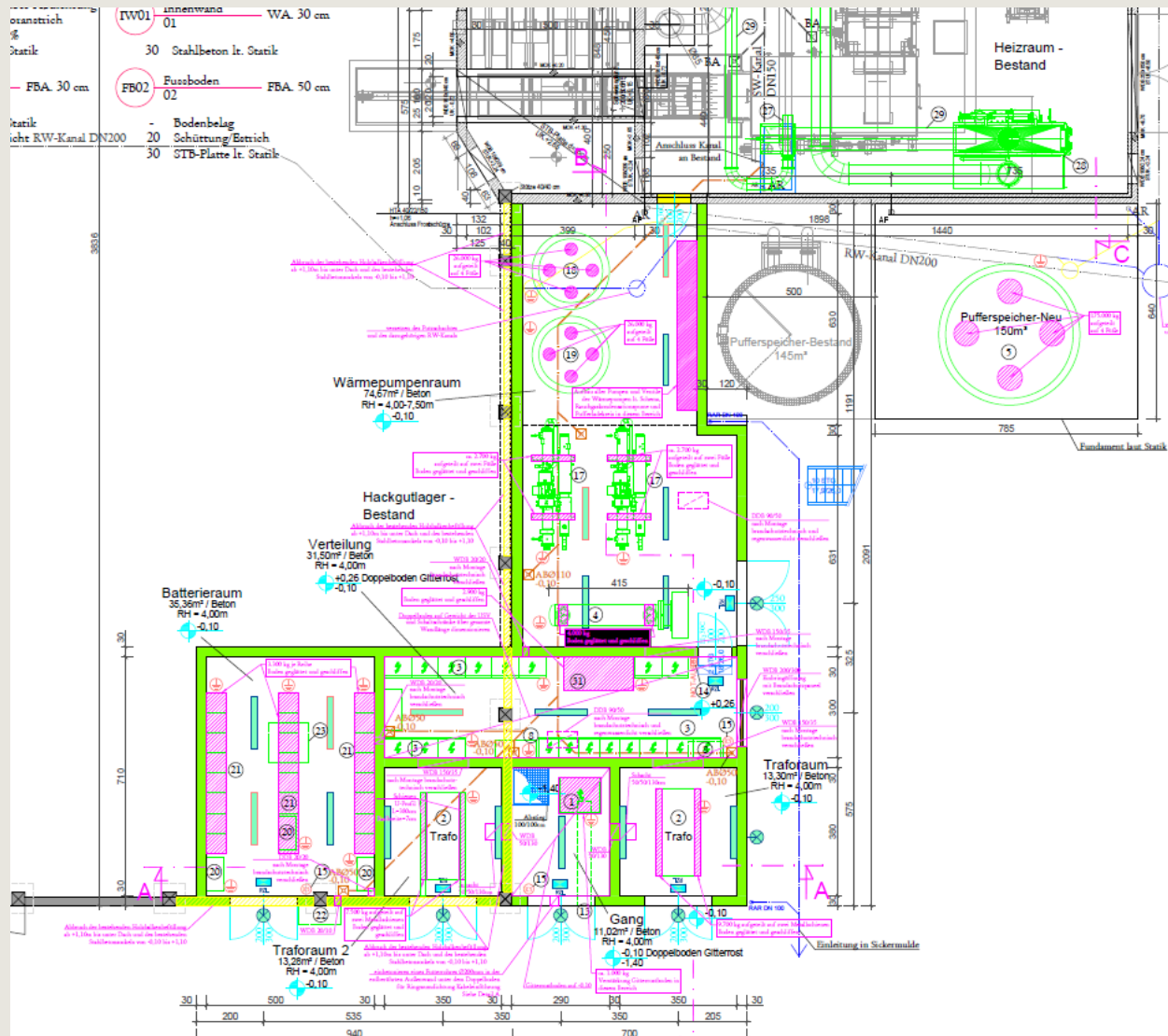

Umsetzungsplan

SCHNITT A-A

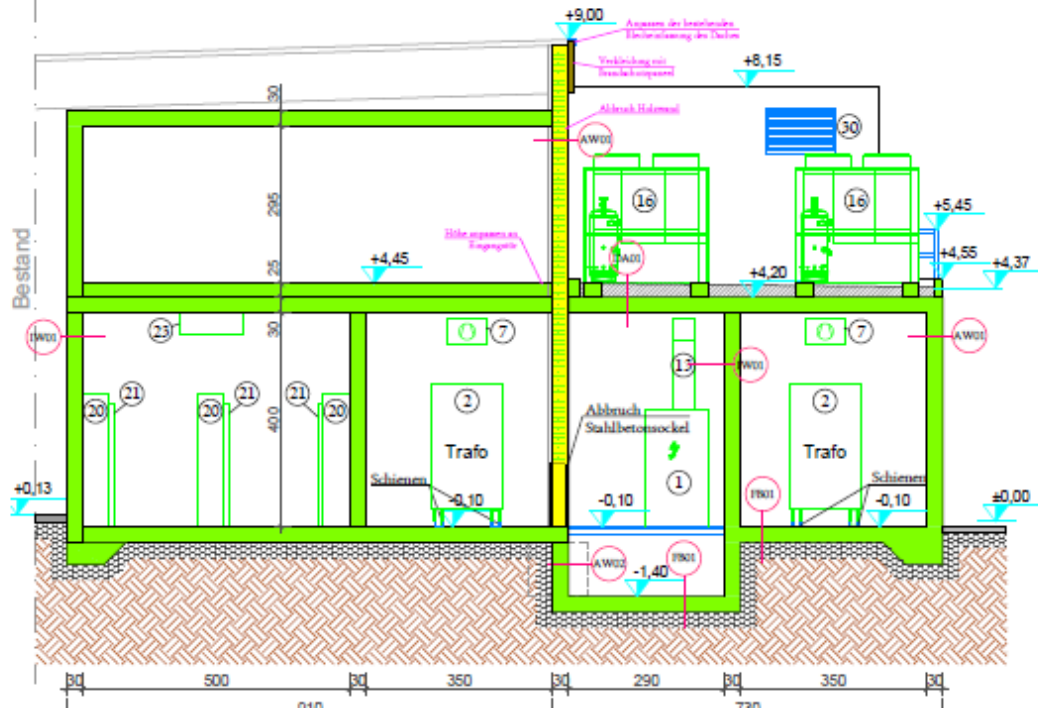

SCHNITT B-B

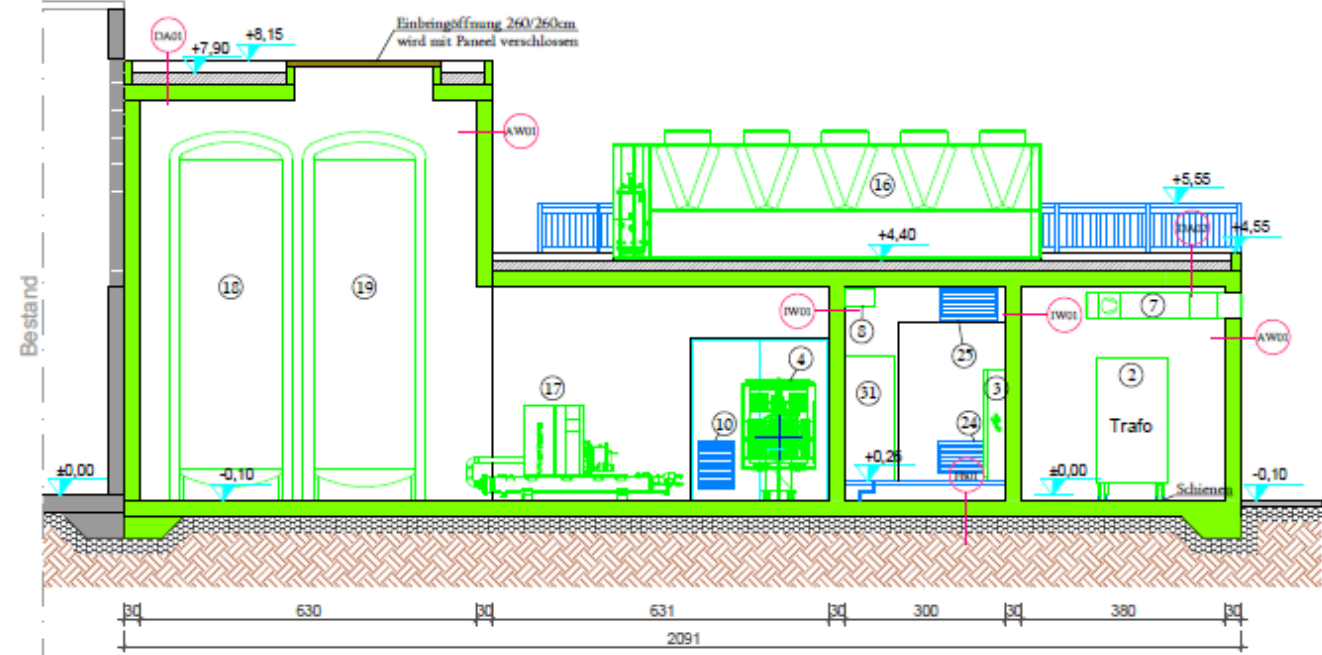

Eckdaten

- Wasser/Wasser Wärmepumpe 2x 600kW (40°C auf 85°C)
- Luft/Wasser Wärmepumpe 2x 600 kW (Umgebungsluft auf 40°C)
- Kaltspeicher 17 m³
- Warmspeicher 17 m³
- Pufferspeicher 2x 150m³ (10h Sommerlast)
- Rauchgaskondensation 40°C
- COP >4
- Abgesichert mittels USV
- Stromversorgung mittels Direktleitung aus Windpark Neusiedl/Weiden (17 WKA / 32 MW), 2,7 km
- Abdeckung Windverfügbarkeit ~80%

Prognostizierter Umwelteffekt

- 1.250 MWh weniger Erdgas => 300 t CO₂ pro Jahr (~120.000 m³)
- 1.200 ATRO weniger Biomasse
- 80 LKW weniger durch Neusiedl => 9 t CO₂ pro Jahr

50% der Wärmemengen werden aus Windstrom erzeugt!

Zeitplan



Begleitende Forschungsprojekte

1. Windvermarktung

2. Sondierungsprojekt Hybrid District Heating

3. Hybrid DH Demo

Ziel: Open Innovation-Entwicklung & Umsetzung von P2X-Geschäfts- & Finanzierungsmodellen durch Hybridfernwärme in Neusiedl

4. HWSP

Heat Water Storage Pooling



HYBRID
DH Demo



green
energy
lab.at

powered by  klima+
energie
fonds









Ihr Ansprechpartner

DI Matthias Lehner, MSc
Prokurist

Energie Burgenland Fernwärme GmbH & Co KG
Kasernenstraße 9
7000 Eisenstadt

Tel +43 (0)5/7770-1720
Mobil +43 (0)664/8344555

matthias.lehner@energieburgenland.at

